

### 1. Name and Parts

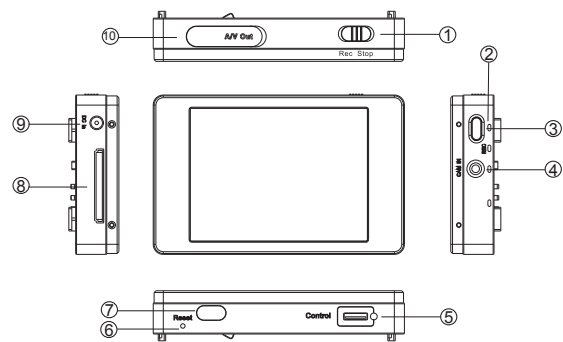

- 1. REC / Stop Button
- 2. Status Bar
- 3. Power On/Off Button
- 4. CAM In Port
- 5. Control Port
- 6. Reset Button
- 7. Infrared Sensor
- 8. Memory Card Slot
- 9. DC In Jack
- 10. AV Out

### 2. Package Content

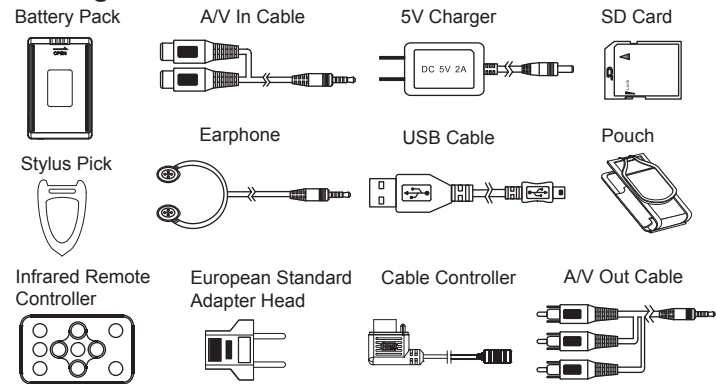

(1)

### 3. Charging Battery

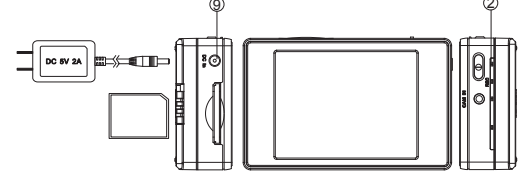

1. Connect the charger plug to the DC In Jack ⑨.
2. Plug the power cord of the charger to an AC wall outlet. The charging starts automatically.
3. The LED bar ② will illuminate red to show the device is in charging mode. Charging time requires about 3 to 4 hours.
4. When charging completed, the red light will turn off automatically.

### 4. Connecting Analog Camera

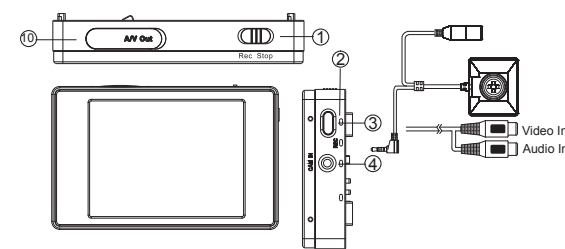

1. Power on the DVR by pressing ②.
2. Plug an analog camera into CAM In Port ③ on the device.
3. To start recording, switch REC/STOP to REC ①.
4. Various recording modes are optional in SETTING MENU.

(2)

### 5. Installing and Remove Battery

NOTE: PV-500L3 has a removable battery. You can purchase extra battery depending on your application. Follows the instructions below to remove or replace a battery.

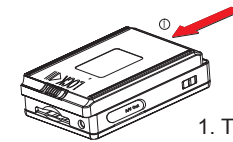

1. To remove the battery, gently push LOCK switch to right side and push battery in red arrow pointed direction.



2. To install the battery, attach the battery to the DVR and gently push the battery in red arrow pointed direction to secure battery and ensure that it is locked properly.



3. Slide LOCK switch in red arrow pointed direction to lock battery onto device.

(3)

### 6. Connect to Wired Controller

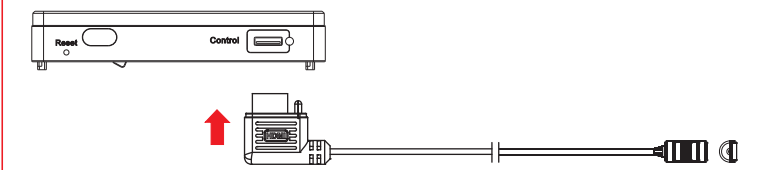

1. Cable controller serves to instantly turn on and off the DVR with instant recording functionality.
2. Plug-in controller cable to Control port in red arrow pointed direction.
3. On the DVR, slide REC/STOP button to Rec position.
4. Slide the controller toggle downward to turn on PV-500L3, the DVR will start video record.
5. To stop recording, slide the controller toggle downward again. The DVR will turn off automatically. The recorded video will be stored on memory card.

Note: If the REC/STOP switch on DVR is in Stop position, cable controller only serves to turn on and off the device.

(4)

### 7. Connecting Computer and Monitor

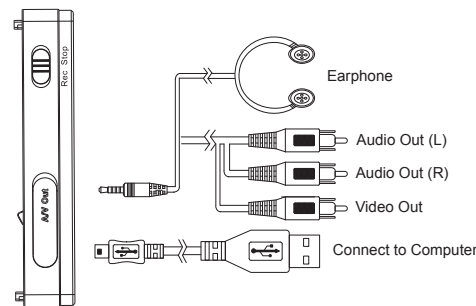

1. Flip up USB port cover. You will see USB port and AV Out port.
2. Insert USB Cable into the USB port and the other end to a computer.
3. Insert A/V Out Cable into the A/V out port and the other end to a monitor/TV.

NOTE: You can also insert Earphone into AV-Out port and use it as a portable device.

### 8. Retrieving Video Footage

1. Video file is stored in the Memory card.
2. There are two methods to retrieve video files.
  - (1) Using USB Cable to connect to computer.
  - (2) Using card reader to retrieve files.
3. Computer detects the storage and user may browse and operate the storage as typical folder directory. i.e. Rename, copy and paste, delete, duplicate, etc.

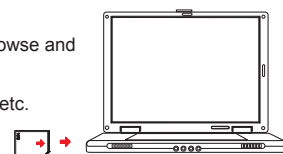

(5)

### 9. Using Infrared Remote Controller and Editing Settings

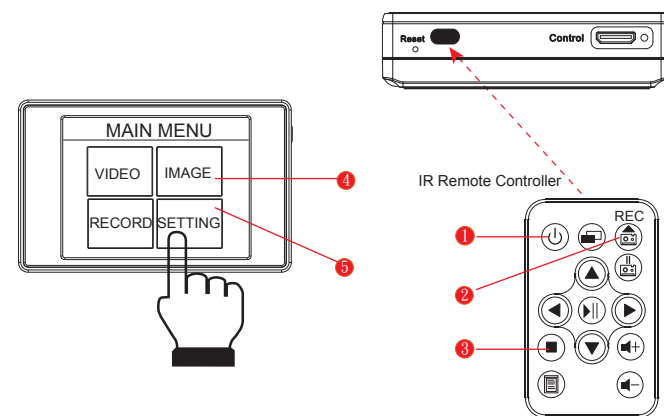

1. Connect a video camera to the DVR and insert the memory card.
2. Turn on the DVR before using the IR remote controller.
3. Aim the IR Remote Controller at the sensor area to control the device.
4. Press Rec ② on the IR remote to start recording and press ③ to stop.
5. Press ③ again to return to Main Menu page.
6. Enter Recorder Setting ⑤ to turn on Motion Detect.
7. Enter Program Setting ④ to edit setting.
8. To turn off DVR, press the Power button ①.
9. You can also tap on touch screen icon to edit settings.

Note: Power button on the IR remote controller only serves to turn OFF the DVR, It will not turn on the DVR.

(6)

### 10. PV-500L3 Connection Illustration

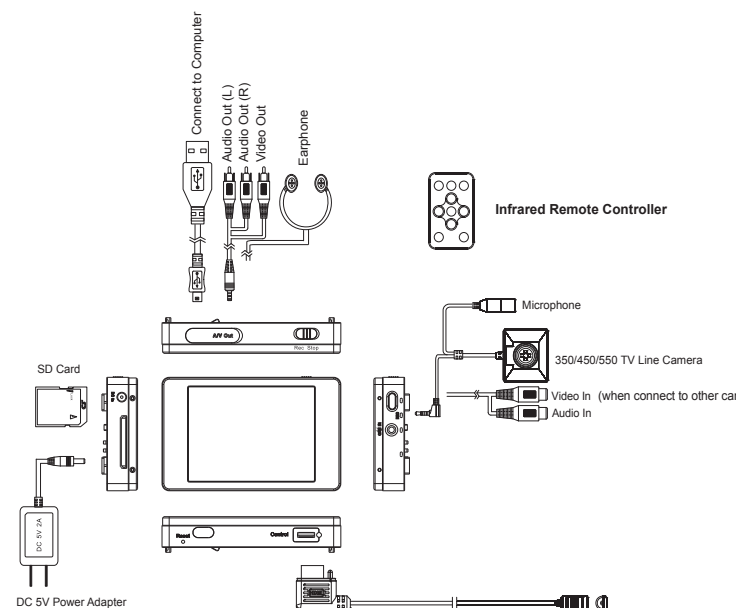

(7)

## PV-500L3 Portable Digital Video Recorder Quick Guide

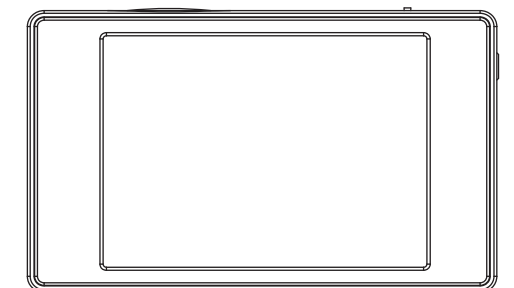

Law Enforcement Products Manufacturer  
LawMate®