

## 1. Names and Parts

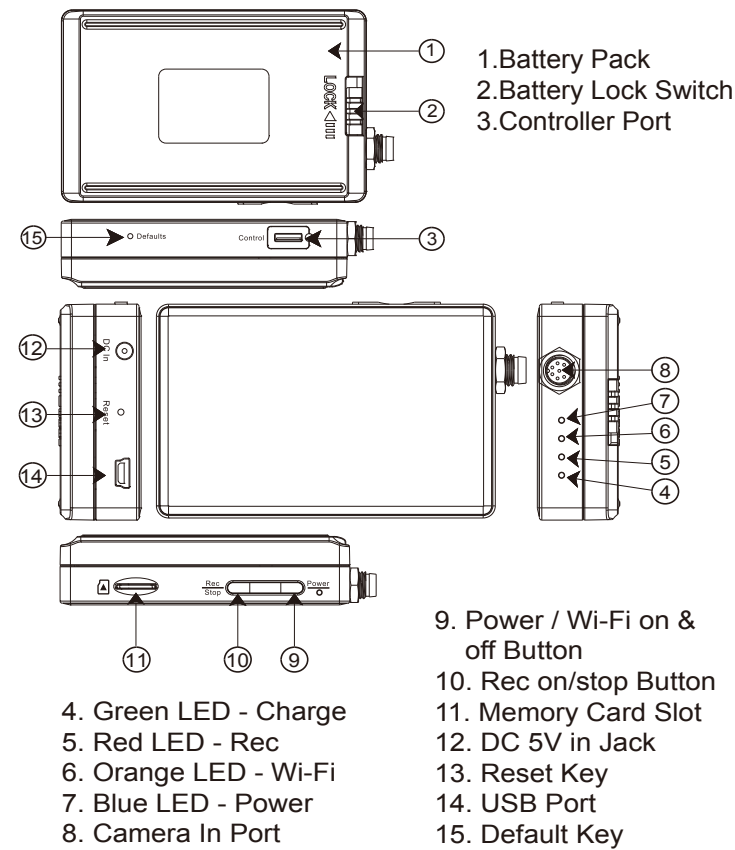

1

## 2. Package Content

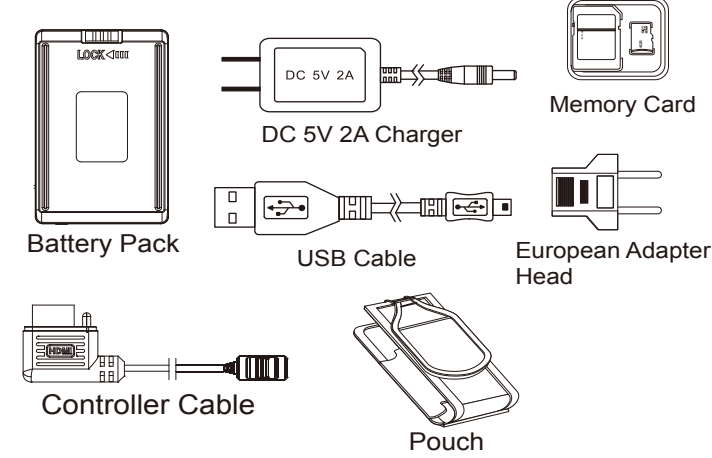

## 3. Install and Remove Battery

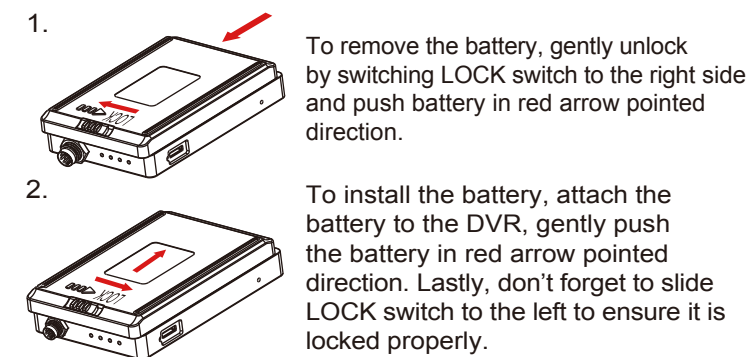

2

## 4. Battery Charging

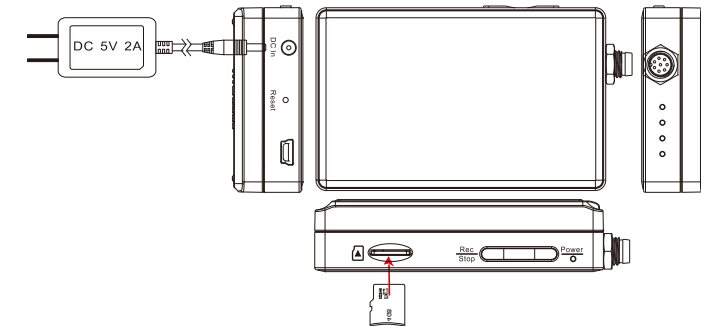

1. Connect the charger plug to the DC In Jack (12).
  2. Plug the power cord of the charger to an AC wall outlet. The charging starts automatically. The device can record while charging.
- Solid green LED ■ - the device is charging.
  - Green LED goes off - the device is fully charged.

## 5. Connecting Camera to DVR

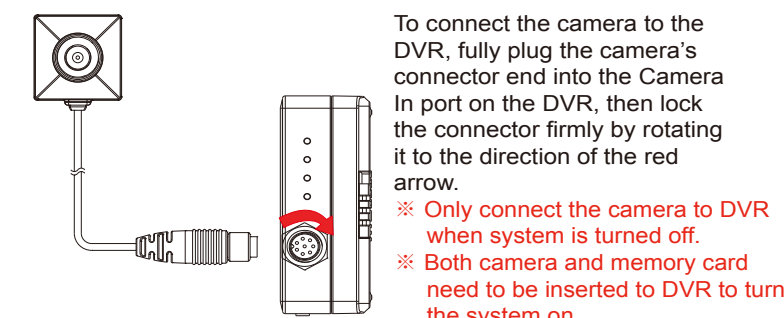

3

## 6. Connect The Wired Controller to The DVR

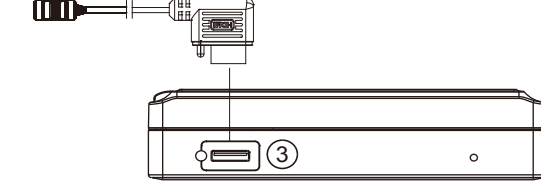

1. Plug in the Controller cable into the Control port (3).
  2. Turn on the Controller, the device starts recording instantly; When turned off, the recording stops and device powered off.
  3. To turn on the device, slide the controller toggle downward and hold for 3 seconds.
  4. To turn off the device, slide the controller toggle downward again and hold for 3 seconds.
- Solid green LED ■ on Controller - the controller is connected.
  - Solid red LED ■ on Controller - the device is recording.

## 7. Connect The DVR to The Computer

With the DVR powered off, plug the USB Cable into the USB port (14) on DVR and the other end to the computer.

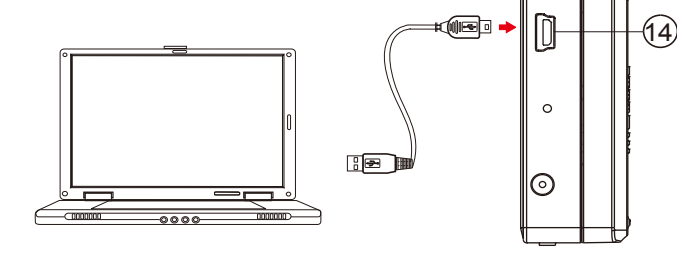

4

## 8. Format The Memory Card

1. The camera must be connected to the DVR first.
  2. Insert the memory card into (11) as the icon shown on the device.
  3. With device powered off, press and hold Rec button (10).
  4. And then press Power button (9) for 3 seconds until you see the blinking red LED.
  5. Lastly, release both buttons at the same time.
- Blinking Red LED ■ + Solid Blue LED ■ - the memory card is being formatted.
  - All lights go off - the formatting is completed.

⚠ **Caution:** To make the memory card recognizable, please be sure to format the memory card before using it for the first time. Please note that formatting on computer is not recommended, for it might result in the failure for the computer to recognize the card.

## 9. Date and Time Setting (for Windows System)

1. From the desktop right-click to open Notepad, create a text file named **settime.txt**
2. On the first line of the file, enter date and time information as year.month.day hours.minutes.seconds  
For example, suppose the time is October 16, 2015 15:00. Then enter **2015.10.16 15:00:00**  
※ There should be a space left between day and hours, and the time format should be the 24-hour format.
3. Save the file to the root directory of the memory card.

5

4. Insert the memory card into the slot, and power on the device. The date and time setting is now completed.  
※ When the date and time setting is completed. The **settime.txt** file should not be visible when you connect the device to the computer again.  
※ Do not remove serial number sticker! Warranty is invalid if the sticker is tampered.

## 10. Operation

1. Power on: Press (9) for 3 seconds.
  2. Recording: With device powered on, press (10) to start or stop recording.
  3. Wi-Fi: With device powered on, press (9) to turn on/off Wi-Fi.
  4. Power off: With no ongoing recording, press (9) for 3 seconds.
  5. Reset: When the device functions abnormally, press (13).
  6. Restore default Wi-Fi password: long press (15) for 4 seconds.
  7. Restore default setting : press (15) for 10 seconds.
- Solid blue LED ■ - power on
  - Solid red LED ■ - recording on
  - Blinking orange LED ■ - device searching for Wi-Fi connection
  - Solid orange LED ■ - device is connected to Wi-Fi
- ※ The device powers off itself when memory card is full.

## 11. Download Videos and Photos From DVR

- Knowing that all video files are stored in the memory card. You can do the following to download videos.
1. Use a memory card reader to transfer files from the card to the computer.
  2. Or, connect the device to the computer with memory card inserted. Turn on the device and it will work as a flash drive.

6

## 12. Specification

Video Spec.	
Algorithm	H.264, JPEG
File Format	MOV, JPG
Video Recording Mode	Auto/Manual/Motion Detection
Recording Capability	1080P / 720P / WVGA
Frame Rate	Up to 30 fps
Wi-Fi Spec.	
Wi-Fi	Built-in Wi-Fi Module (IEEE 802.11b/g/n)
Wi-Fi Protocol	RTSP
Storage & I/O	
Memory Type	Memory Card ( Support up to 32GB)
Data Interface	Mini USB 2.0
Misc.	
Disguised Mode	Stand-By, Power-Off
Date/Time Table	YYYY.MM.DD, HH.MM.SS
Snapshot	Record And Playback Video (on smartphone)
Power	
Power Input	DC5V
Power Consumption	380mA-440mA(Wi-Fi OFF)(Wi-Fi ON + 80mA)
Charging Time	240 min(700mA)
Battery Input	DC 3.7V / 2200 mA Lithium Battery
Battery Lifetime	240min(1080P / Wi-Fi ON)
	270min(1080P / Wi-Fi OFF)
	270min(720P / Wi-Fi ON)
	300min(720P / Wi-Fi OFF)
	300min(WVGA / Wi-Fi ON) 330min(WVGA / Wi-Fi OFF)
Recording Time	160min @ 1920x1080resolution ( 16GB Memory Card )
Physical	
Dimension	85x54x21mm
Weight	104g (With Battery)

7

## PV-500Neo Palm-sized Wi-Fi DVR

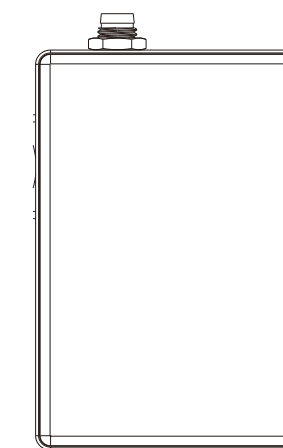

LawMate, innovation never stops

**LawMate**

V1.0